

# MANUALLY ACTUATED VALVES SERIES MVHB WITH VERTICAL LEVER



Valves are available with or without detent as well as functions 5/2 and 5/3 with closed, pressured or exhausted centre. Valves can be mounted by using the holes on the valve body, type MVHB 220 can be also mounted into the panel with hole dia. 18.5 mm.





This valve series contains rubber gaskets.





Series	MVHB 220	MVHB 300	MVHB 500
Ports	G1/4" (G1/8" for exhaust ports 3 and 5)	G3/8"	G1/2"
Flow capacity [Nl/min]	1000, or 890 for 5/3 function	1880 for 5/2 and 5/3 function	2270 for 5/2 and 5/3 function
Working pressure [MPa]	0 to 0.80	0 to 1.20	0 to 1.20
Weight [kg]	0.193, or 0.234 for 5/3 function	0.438, or 0.487 for 5/3 function	0.519, or 0.560 for 5/3 function
Temperature range [°C]	ambient temperature -5 to +60		

## Order codes

### PMVHB 220 4TV SPM

Size	
220	series MVHB 220, thread G1/4"
300	series MVHB 300, thread G3/8"
500	series MVHB 500, thread G1/2"

Function	
M	 5/2 with detent
SPM	 5/2 without detent
CM	 5/3 with detent, closed centre
CSPM	 5/3 without detent, closed centre

Function	
PM	 5/3 with detent, pressured centre
PSPM	 5/3 without detent, pressured centre
RM	 5/3 with detent, exhausted centre
RSPM	 5/3 without detent, exhausted centre

## Dimensions

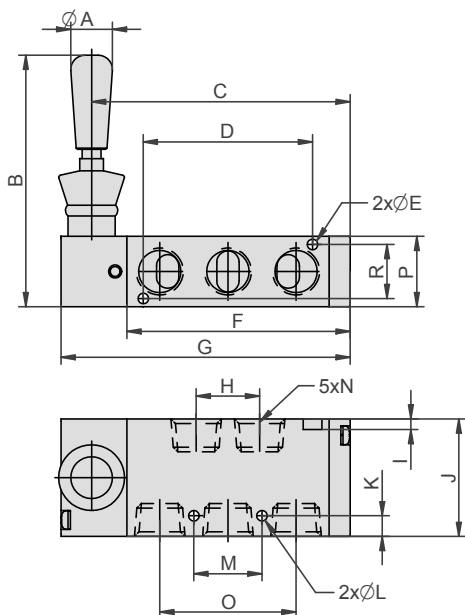

Series	Function	A	B	C	D	E	F	G	H	I	J	K	L	M	N	O	P	R
220	M, SPM	18	95	67	—	—	57	77	21	—	35	7	4.2	20	G1/4"	36	22.3	—
	CM, PM, RM	18	95	74.5	—	—	59	85	21	—	35	7	4.2	20	G1/4"	36	22.3	—
	CSPM, PSPM, RSPM	18	95	86.5	—	—	71	97	21	—	35	7	4.2	20	G1/4"	36	22.3	—
300	M, SPM	18	107	—	60	3.2	—	114	30	—	47	4.7	4.5	26	G3/8"	52	30	25
	CM, PM, RM	18	107	110	60	3.2	—	123	30	—	47	4.7	4.5	26	G3/8"	52	30	25
	CSPM, PSPM, RSPM	18	107	129	60	3.2	—	142	30	—	47	4.7	4.5	26	G3/8"	52	30	25
500	M, SPM, CM, PM, RM	18	107	111	72	4.5	95	124	27	4.5	50	8.8	4.5	29	G1/2"	58	30	23
	CSPM, PSPM, RSPM	18	107	129	72	4.5	114	142	27	4.5	50	8.8	4.5	29	G1/2"	58	30	23



Valves series MVHB 220 can be mounted into the panel or by holes in the valve body. Valves series MVHB 500 can be mounted only by holes in the valve body.

